

HOT MELT APPLICATOR SYSTEM

BS 60



ADDRESS : 62 Dangjeong-ro, Gunpo-si, Gyeonggi-do
, Korea (경기도군포시당정로 62)

TEL : +82-31-456-4190

FAX : +82-31-456-4191

E-Mail : webmaster@phalbok.com

<http://www.phalbok.com>

◆ Please make sure to observe it! ◆

© If not observed, failure and accident may occur.

1. Electric Specification

VAC Hz Kw

2. Do not turn the pump switch ON until it reached to the set temperature.
3. Switch off the power before the panel is opened.
4. Please make sure to read the operating manual before the installation and operation of the system.
5. At time of equipment maintenance and repair, switch off the MAIN power and wait until the temperature is dropped.
6. At time of equipment operation, do not use the pressure higher than required.
(Do not operate the machine in a manner prohibited or not instructed in the manual.)
7. At time of filter change, change it after removing the pressure with the pump switch OFF.
8. As the surface of TANK and GUN is so hot and may cause burns, so never fail to wear a cotton gloves to touch it.
9. When the HOSE is connected to the TANK or GUN, the radius should be more than 200 mm, and fasten it rightly not to be twisted.

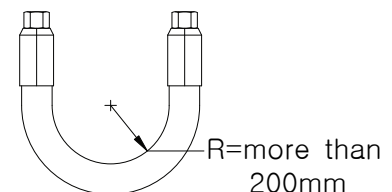

◆ Cleaning the tank ◆

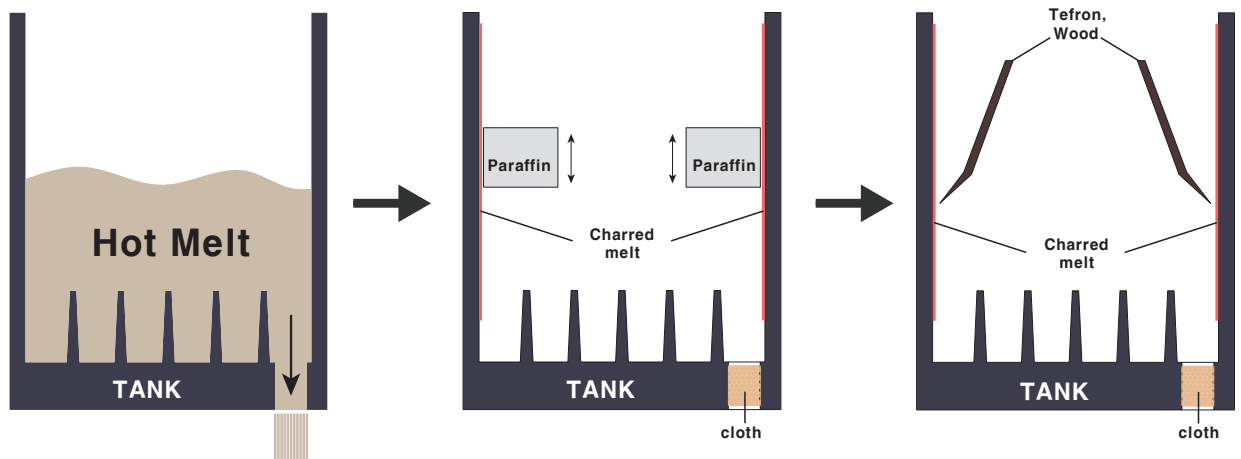

1. Discharge the remaining hot melt from the inside of the tank.
2. Stop the pump inlet port with a cloth, etc.
3. Remove the charred melt from the wall and grid inside of the tank using paraffin, etc.
4. If the charred melt is not removed with paraffin, scrub it using a safe tool (a wood knife, a teflon knife) that does not cause damage to the teflon coated inside of the tank.
5. Wipe the scraped carbide from the tank completely.
6. Separate the tank filter from the tank and clean it
7. Stop the tank filter blank and disengage the hose
8. After putting hot melt into the tank and melting it, discharge it until carbide is not coming out any more.
9. Replace the tank filter and the hose to complete the cleaning process of the tank.

◆ 터미널 전원 연결 방법 ◆

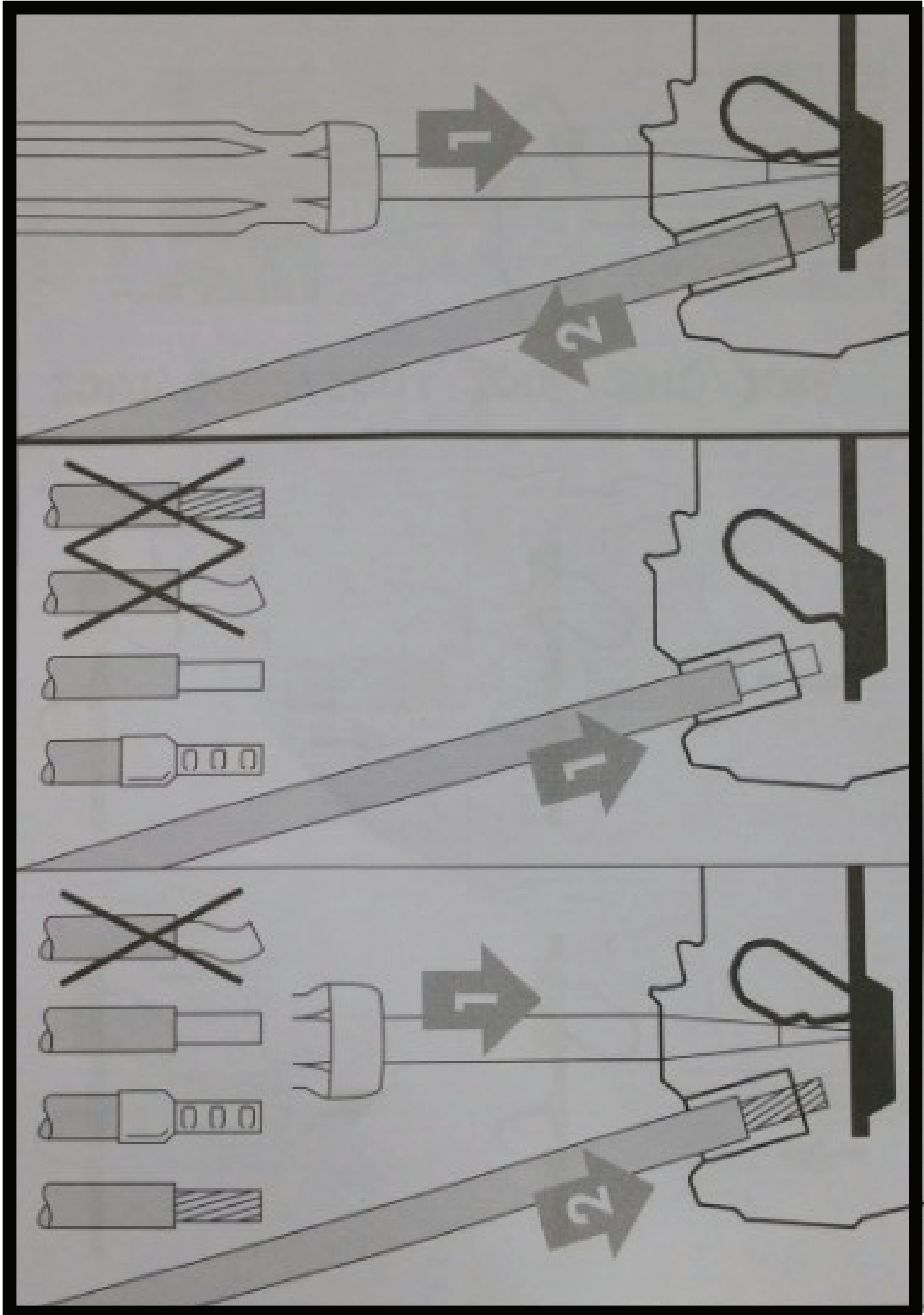

– Table of Contents –

1. Caution and cares to be taken for safe use	
(1) General	1
(2) Worker Requirements	1
(3) Important Caution for Safety	2
(4) Position of label	4
2. Outline of BS-SERIES HOT MELT APPLICATOR	6
3. Installation of BS-SERIES HOT MELT APPLICATOR	
(1) MELT UNIT Installation	7
(2) HOT MELT HOSE Installation	7
4. Example of Electrical Wiring	
(1) Main electrical power wiring connection	9
(2) INTERLOCK CIRCUIT between HOT MELT APPLICATOR PUMP MOTOR and main machine	9
5. Operation	
(1) Cares to be taken prior to operation	11
(2) Operation	12
6. MODEL BS-60 Details and Specification	13
7-1. Main Switch panel control equipment and pilot lamp	14
7-2. Explanation about various electrical parts	15
7-3. Motor Specification and characteristics	18

8. Part list

(1) MAIN SWITCH PANEL	19
(2) Interior panel in the front	20
(3) Disassembly drawing and explanation for NINO TANK	21
(4) Disassembly drawing and explanation for PUMP BLOCK	24

9. How to clean MELT UNIT27

10. Finding problem and solution when using HOT MELT APPLICATOR28

11. Finding problem and solution when using HOT MELT29

◆ CE LABEL

◆ ELELCTRICAL DRAWING

◆ TEMP CONTROLLER (TCS-500 SERIES)

◆ DISASSEMBLY DRAWING AND EXPLANATION
HOT MELT GUN

1. Basic Requirements for safe use

We, Phal Bok System, are very grateful for purchase of our products. Considering the fact that our HOT MELT APPLICATOR uses hot melt at high temperature, high pressure and high speed, please get familiarized with Service Manual for safety of operator and observe as required. Failure to observe Service Manual may cause bodily injuries and equipment damages.

(1) General Cares to be taken

- * Please be sure to get familiarized with Service Manual, prior to installation, operation and repair of HOT MELT APPLICATOR.
- * Please have designated workers only be engaged in operation of the machine.
- * When something goes wrong with the machine when in operation or it works abnormally, stop the machine immediately and contact Phal Bok System to get technical direction.
- * Do not operate the machine in such a manner as prohibited or not instructed in Service Manual.
- * We are entirely not responsible for any breakdown and bodily injuries caused by installation, operation and repair not conforming to the Service Manual. With respect to what is not specified in MANUAL, please inform us for confirmation.



It indicates first-hand exposure to danger
Likely to cause death or serious injury.



It indicates potentially dangerous situation.
Likely to cause serious injury or equipment failure. .



It indicates potentially dangerous situation. .
Likely to cause mild injury or equipment failure.



It indicates necessary and useful information
required for operation and repair.

(2) Mechanical operators Requirements

- * Workers to meet the following requirements are allowed to operate and repair the machine.
 - ① Qualified worker
 - ② Delegated worker
 - ③ Educated worker

(3) Important caution for safety

◆ Transfer of equipment



Ⓢ Do not raise or transfer the machine without being supported by mechanical lift.

◆ Wearing protective equipment



Ⓢ When installing, operating and repairing HOT MELT APPLICATOR or working around it, please be sure to wear protective goggle, gloves (made of leather) and clothes.

◆ Danger of high pressure ejection



Ⓢ Ejection of high pressure melt resin is likely to cause injury like burn. Do not operate the machine in such a manner as prohibited or not instructed in Service Manual.

◆ Prohibition from operating the machine



Ⓢ Personnel without having professional education is not allowed to handle the machine.

◆ Safety cover



Ⓢ Stop operating the machine before opening cover.

◆ Grounding.

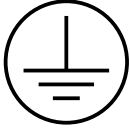

◆ Electrical hazard.



- ⦿ Before operation, close the machine with locking device.
- ⦿ Turn off power before approaching electrical equipment.

◆ Familiarity with service manual.



- ⦿ Before installation and operation of the system, get familiarized with service manual.

◆ Burn hazard (hand off, do not touch)



- ⦿ After cutting off power, wait to operate the machine until temperature will go down.

◆ Caution



- ⦿ Stop operating the machine before opening cover.
- ⦿ When replacing filter, remove pressure.
- ⦿ Do not touch the surface which is hot.
- ⦿ Failure to follow this instruction may cause burn hazard etc.

(4) LABEL POSITION

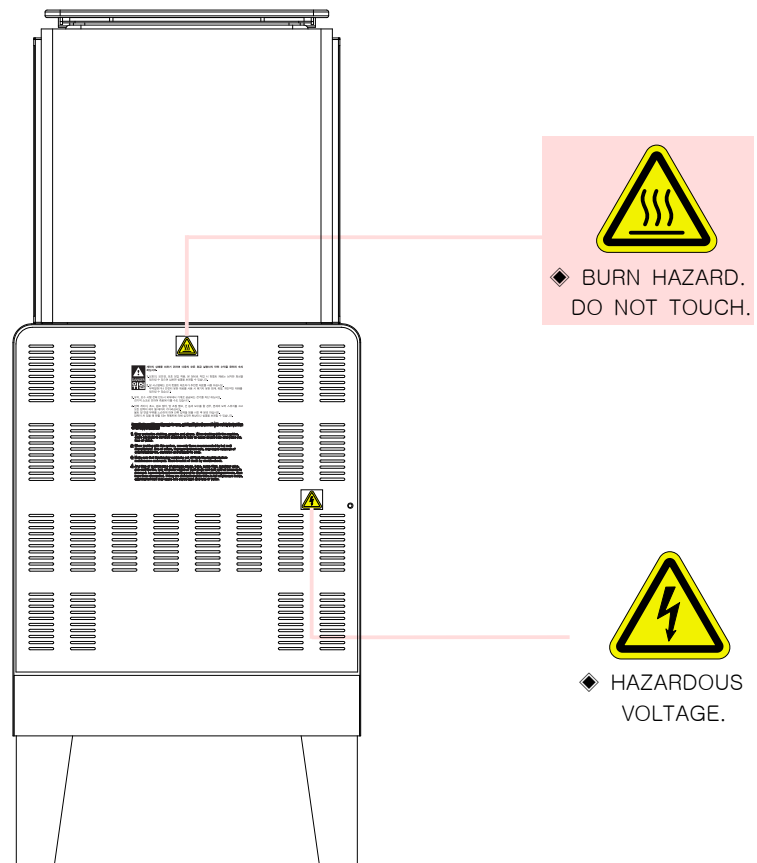
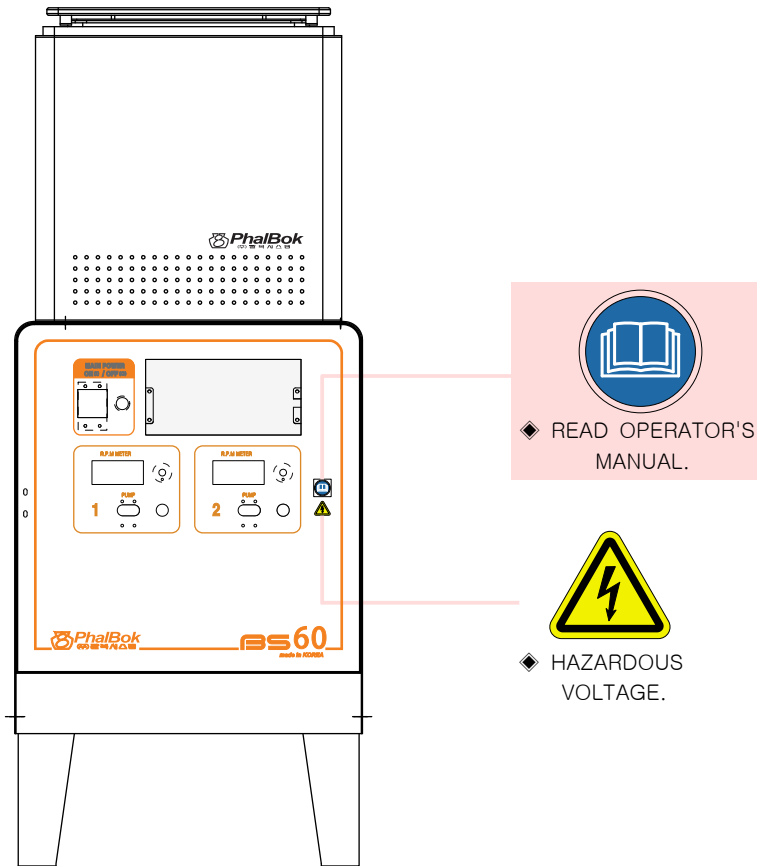

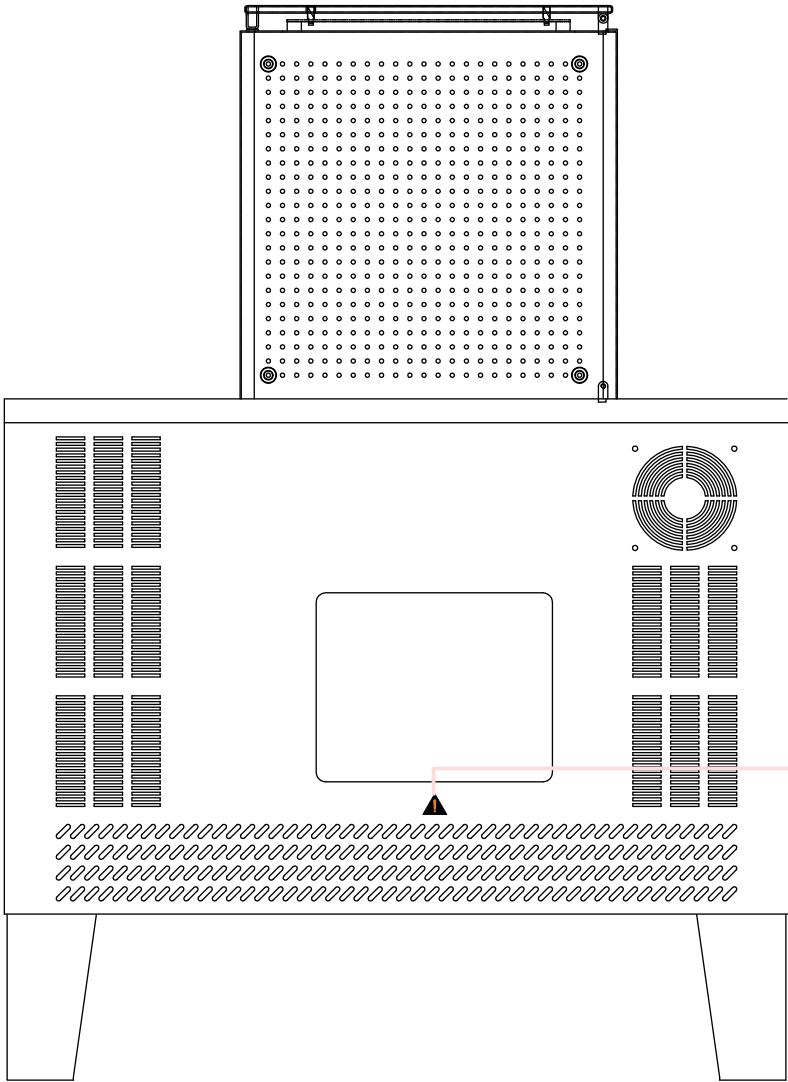
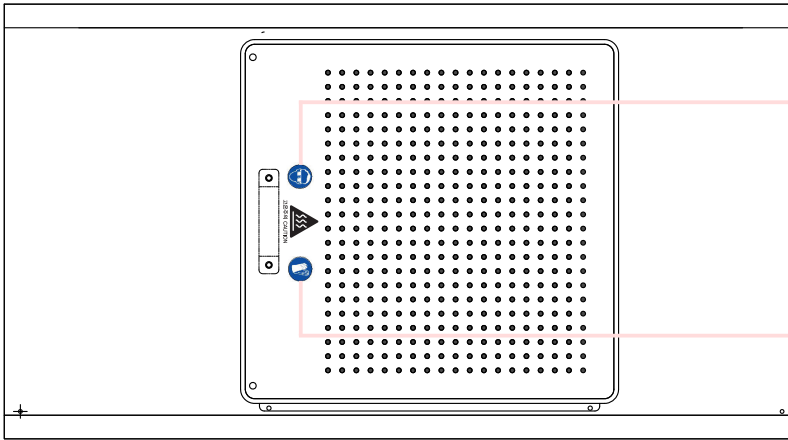

2. Outline of BS-SERIES HOT MELT APPLICATOR

BS-SERIES of PhalBok System are designed intended for adhesion or sealing by automatic or manual injection using pumping after melting adhesives. MELT UNIT is composed of tank where adhesives are molten, GEARED MOTOR and GEAR PUMP necessary for pumping, temperature controller, electrical facilities, enclosure etc.

- * BS-SERIES is capable of pumping molten adhesive made of EVA , rubber , Polyurethane , Polyamide , Polyester and thermoplastic Plastics.
- * It enables Teflon coating inside the tank, thereby varying physical properties of adhesive and carbonizing adhesive. MELT GRIDE boosts MELT RATE by increasing thermal conduction from heater.
- * PUMPING SYSTEM enables its geared motor to set gear pump in motion and adjusts pressure and discharge by flow control valve.
- * BS-SERIES can use either of 1 – 2 HOSE & GUN or 1 – 4 HOSE & GUN or 1 – 6 Hose & Gun, depending upon model of temperature controller.
- * Temperature control system in frontal part uses RTD Sensor.
Temperatures of respective parts are shown in digital Composed of main breaker, Pump Breaker, temperature control system etc.
QUICK CONNECT is used to make easy electrical connection with and disconnection from HOSE.
- * User is required to supply incidental facilities such as main power supply and injection control system
- * MELT UNIT in BS-SERIES has the following built-in safety systems.
 1. S/W & LAMP to prevent temperature from excessively rising, which blocks the supply of electrical power to tank heater : prevent tank from being over-heated by failure of temperature controller in tank or over-temperature setting in tank.
 2. to protect PUMP and MOTOR, temperature controller OPERATION Contact point built-in BREAKER SWITCH works to prevent overload.
 3. Breaker and fuse, which prevents electrical overload of MELT UNIT and power failure at a time of short circuit.
- * With simple mechanical structure and high reliability, NINO SERIES can be used as common tool to do all works due to easy detection of failure and easy repair.

3. Installation of NINO-SERIES HOT MELT APPLICATOR

(1) Installation of MELT UNIT

- ① HOT MELT TANK is to be horizontally installed at place where it is not exposed to vibration and convenient to control and operate, and solidly assembled through mountain hole on the floor (to be solidly installed to prevent overturning or moving)
- ② Hot Melt tank is to be installed at a place where it is not influenced by external wind.
Ex) a. Not where it is directly exposed to wind through window.
b. Not within the reach of wind generated by electrical fan, air conditioner, control box FAN etc.
c. at a place elevated from the floor.
(for protection of the machine and at a time of floor being cleaned using water)

(2) Installation of Hot MELT HOSE

- ① Hose is to be assembled or disassembled after HOT MELT is molten by heat.
(When it is bended at bend radius of less than 200mm, inner base materials , Heater and the like may deviate from the position or be broken)
- ② While Hose is being assembled or disassembled, tank may be lifted or tilted to the extent that Hot Melt in the tank does not spill over.
- ③ When assembled or disassembled, hose should not be twisted.
- ④ When hose is installed, its minimum bend radius shall exceed at least 200mm.
(If bent unmolten, hose may be broken)
- ⑤ When suspended from ceiling or pillar, any part of hose should not be tightened or hindered from radiating heat. (At this time, use HOSE BAND)

*** Cares to be taken when installing Hot melt hose ***

1) HOSE is to be installed with bent part of not less than 200mm.

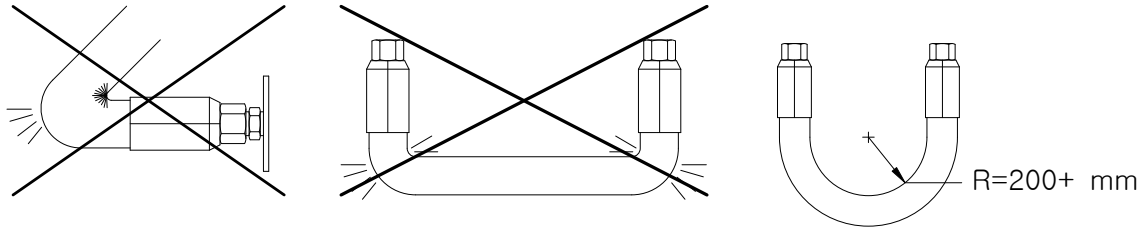

2) When two+ hoses are used, they should be 15+ mm far away from each other for a safety's sake.

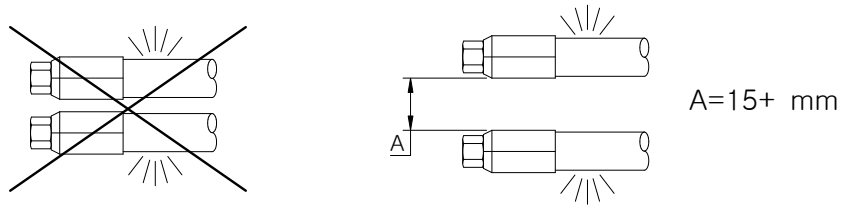

3) If any part of hose is fixed, it should not be tightened or kept from radiating heat.

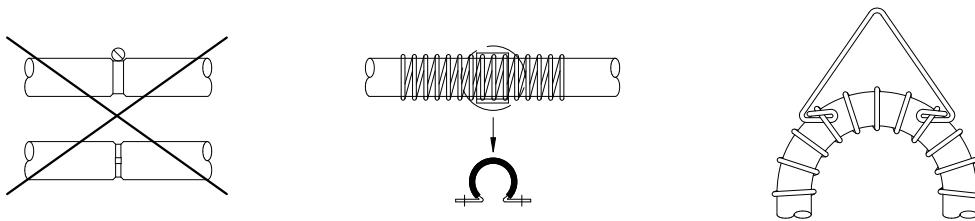

4) When connected with tank or gun, hose should be assembled by holding nipples at both tips of hose. If assembled by holding nipple at either tip, hose may be or is expected to be broken caused by twisting.

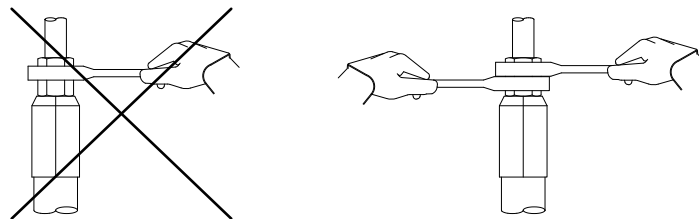

5) At a time of hose being connected, nipples appropriate for intended purpose should be chosen.

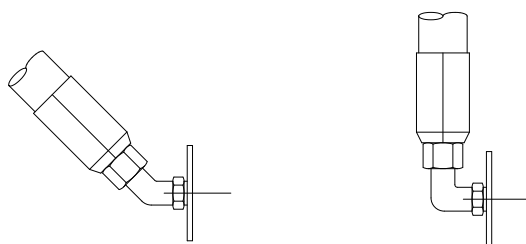

4. Example of electrical wiring

(1) MAIN POWER DISTRIBUTING WIRE

- ① NINO-SERIES should be supplied power in a single-phase 1 ϕ , 220vac, 60Hz, absolutely with grounding for safety's sake.
- ② Thickness of electrical wires to be connected with main power depends upon capacity of NINO-SERIES.
- ③ MAIN POWER CONNECTION METHOD.

EX) ① 1 ϕ 220[VAC]

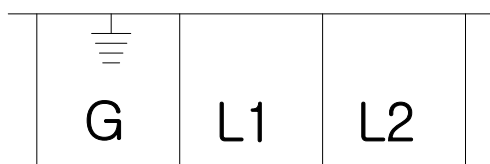

Electrical power in single-phase 220VAC, 60Hz should be connected with L1 and L2 and G terminal should be grounded.

② 3 ϕ 220[VAC]

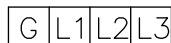

③ 3 ϕ 380[VAC]

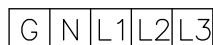

(2) INTERLOCK circuit between Hot Melt APPLICATOR Pump Motor and main machine

- ① In case main machine comes to emergency halt or stops working (during mealtime or break), it secures safety, helps energy saving and extended longevity of the machine by electrical configuration of INTERLOCK circuit between PUMP MOTOR and main machine.
- ② EXAMPLE OF ELECTRIC CIRCUIT INTERLOCK

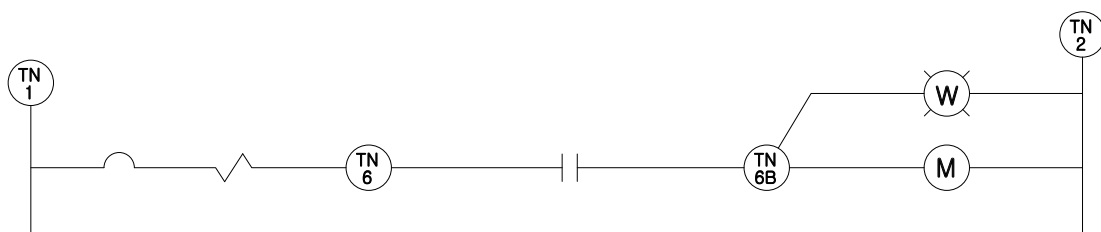

The machine is released from the factory with input contact point for operation connected with and .

③ Electrical wiring of Solenoid coil in Auto Gun

- ◆ When Solenoid coil in AC 110V is used.

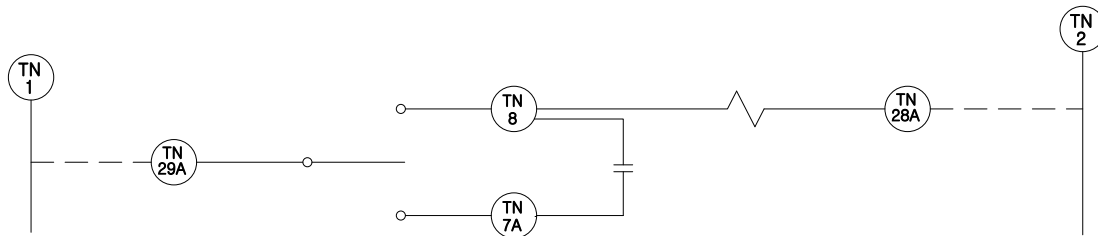

- ◆ When Solenoid coil in single-phase AC 110V is used.
AC 110V electrical power is separately connected with Terminal block 29A and 28A.
If terminal block 1 & 29A and 2 & 28A are jumped.
be sure that jumping lines should be eliminated.

- ◆ When DC Driver is used.
Output terminal No. 3 and 4 in DC Driver are to be connected with Tank terminal No. 29A and 28A, respectively. Tank terminal No. 8 and 7A are to be jumped.
If terminal block 1 & 29A and 2 & 28A are jumped.
(be sure that jumping lines should be eliminated)

- ◆ When Solenoid coil in AC 220V is used.

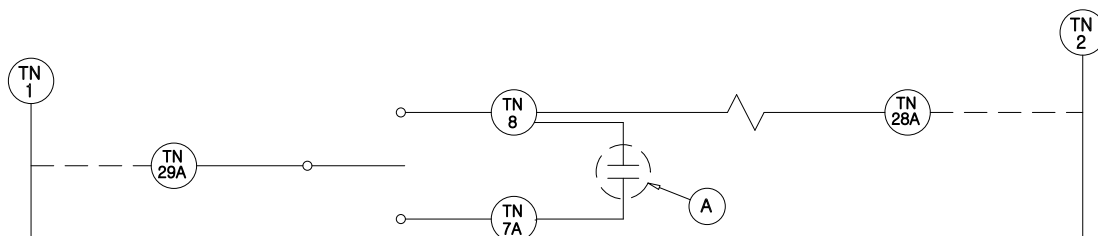

- ◆ Terminal No. 1 and 29A are to be jumped with terminal No. 2 and 28A, respectively.
- ◆ Relay contact point is to be connected with (A) in main machine.

- ◆ When Air Solenoid coil in DC 24V is used
 - ◆ When DC 24V is output from main machine, it is connected with terminal of Air Solenoid coil.
 - ◆ When DC Driver is used, DC power output from DC output driver terminal No. 3 and 4 is to be connected with terminal of Air Solenoid coil. Relay contact point or sensor output is to be connected with DC driver terminal No. 6 and 8.
- ◆ For works requiring to be done at high speed or using high pressure and high viscosity, it is better use DC Driver.
- ◆ Solenoid coil in Auto Gun needs to be removed from the main machine.

5. Operation

(1) Cares to be taken prior to operation

- ① Final checking is required with respect to how tank, hose and gun are installed and electrical circuit prior to operation.
- ② Remove fire hazards and dangerous articles inside or around HOT MELT System tank.
- ③ Consult with the manufacturer as to how to use HOT MELT (adhesive).
- ④ After turn on main power S/W in MELT Unit. Tank, Hose, Gun temperature are set. Generally, temperature of AUTO GUN is to be set at one recommended by manufacturer. HOSE temperature is to be set at 5°C – 10°C lower than that of GUN and temperature of Tank to be set at 5°C – 10°C lower than that of hose.
- ⑤ After being turned on, the machine is preheated for 30– 60 minutes, varying depending upon voltage condition, ambient temperature, type of HOT MELT adhesive (EVA, POLYAMIDE, POLYESTER, APP, RUBBER and so on BASE POLYMER).. Select most suitable pre-heating time.
- ⑥ After checking if there remain foreign articles inside the TANK, fill the tank up to 5cm from the top with HOT MELT adhesive recommended by its manufacturer. (restriction on carbonization inside the tank)
- ⑦ As use of replacement adhesives (there is a concern that different adhesives may be mixed) or cleaners are likely to cause heat, flame, toxic gas, poor adhesion or mixing , consult with the manufacturer before replacement or using cleaners.
- ⑧ Liquid or gas to be used for the purpose of cleaning or preventing carbonization inside the tank should be non-inflammable at operating temperature.

◎ Caution and reference

- ① As HOT MELT ADHSIVE undergoes gradual chemical changes in designated operating temperature over time, do not have it pre-heated more than is necessary. (Gelation, carbonization retardation, energy saving)
- ② Do not fill in tank with too much HOT MELT ADHESIVE to spill over.
- ③ Use HOT MELT Adhesive in temperature as lowest as possible with reference to one designated by its manufacturer. (prevention of carbonization and energy saving)
- ④ Adjust FLOW CONTROL VALVE to limit supply of HOT MELT Adhesive to a minimum quantity. (Prevention of motor overload and GEAR PUMP abrasion)

(2) Operation

- ① Check to see if respective temperature of Tank, Hose and Gun reach those set.
- ② Check if Hot melt adhesive inside the tank is molten enough to be for minimal use.
- ③ Be sure to check if HOT MELT ADHESIVE inside the tank is molten enough to enable DRIVE SHAFT to rotate.
- ④ Then, switch PUMP on and start to work automatically or manually.
- ⑤ After pumping is done, switch the pump off and then turn main switch off.
- ⑥ How to adjust injection of Hot melt adhesive.

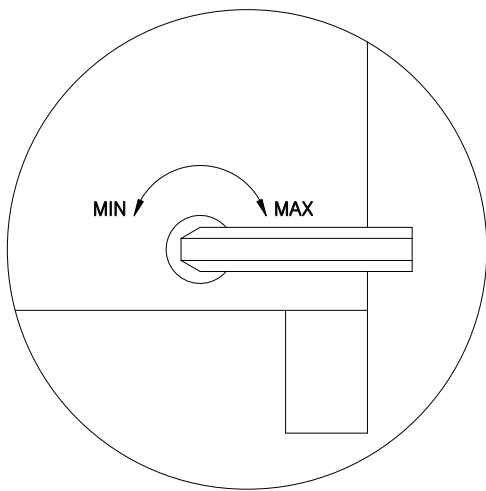

- o When injection is not enough
turn F.C.V clockwise with 6mm L wrench,
enabling it to discharge optimal amount
- o When injection is excessive
turn F.C.V counterclockwise with 6mm L wrench,
enabling it to discharge optimal amount.

※ Caution

If F.C.V is fully shut off, be careful that AG-2000 GUN may not work due to high pressure of discharged melt. Then, turn F.C.V counterclockwise. Do not shut off F.C.V completely.

6. MODEL BS-60 Details and (SPECIFICATION)

- ◆ Operating viscosity : 50,000 CPS
- ◆ TANK capacity : 60 Kg (132lbs)
- ◆ MELT RATE : 35 Kg / hr
- ◆ Maximum available temperature : normal - 230 °C (highest 250°C)
(OPERATING TEMPERATURE RANGE)
- ◆ Temperature deviation : ± 1 °C
- ◆ PUMP pressure : 0 - 7 Kg/cm² (MAX)
- ◆ HOSE quantity : 1 - 6 EA (OPTIONAL)
- ◆ Electrical power : "Refer to electrical drawings"
- ◆ MELT UNIT weight : 125 Kg
- ◆ MELT UNIT standard

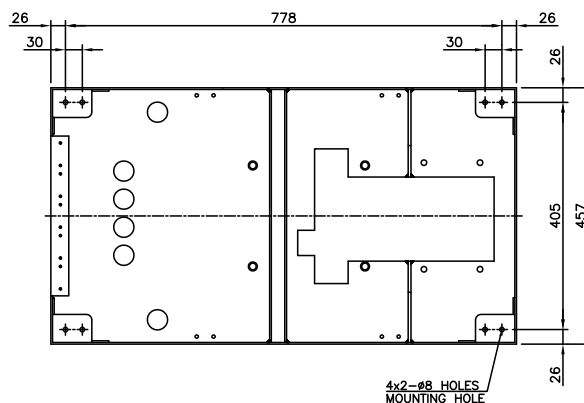
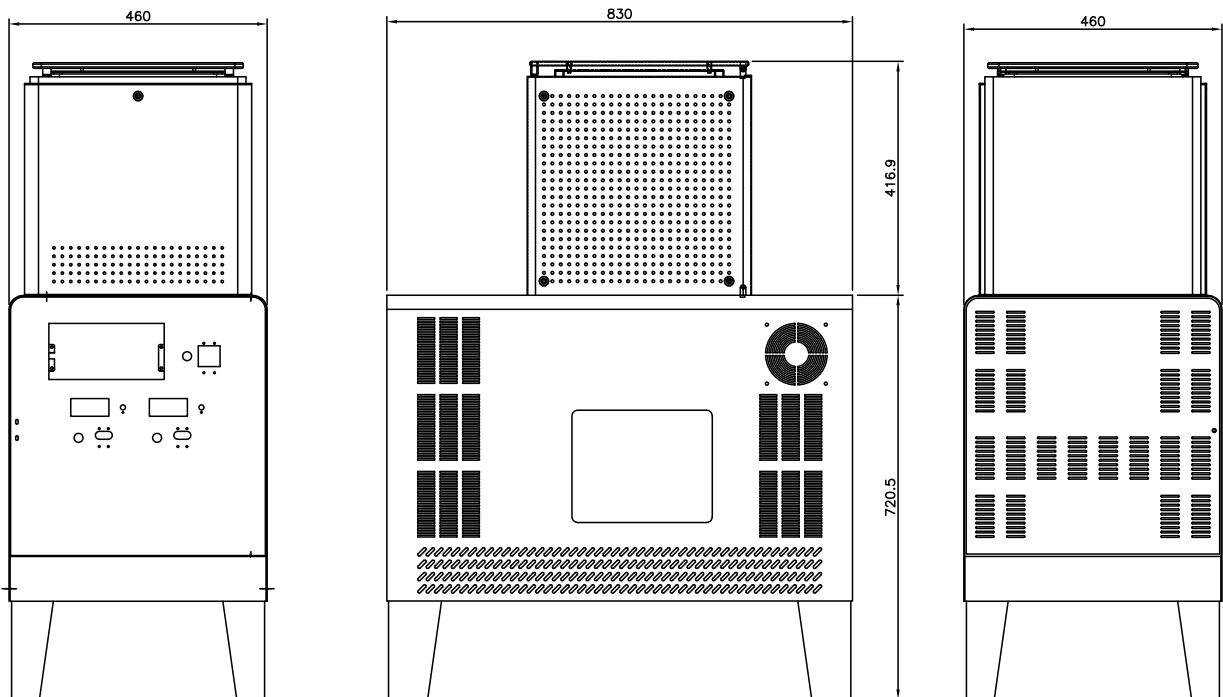

7-1. Main switch Panel control equipment and pilot lamp

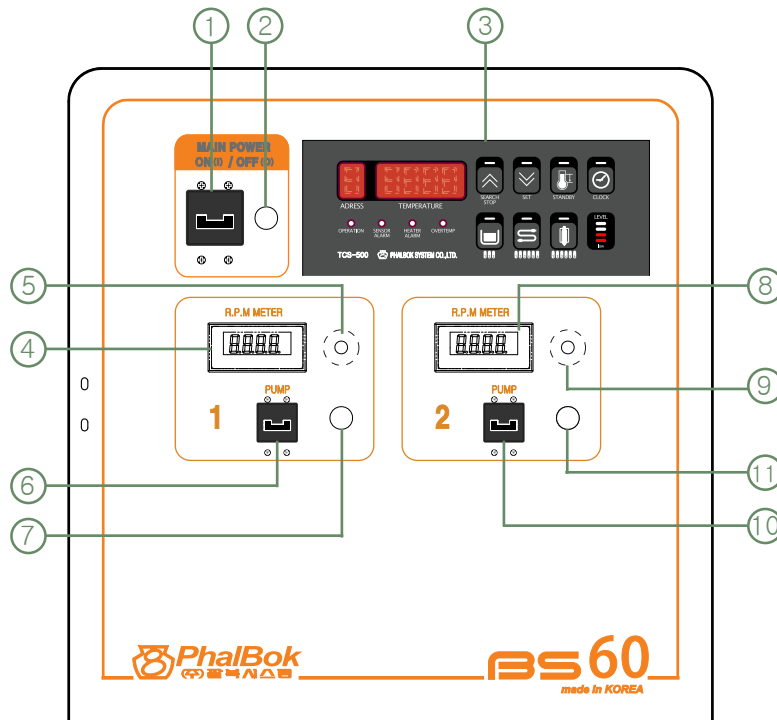

- ① Main power S/W (Breaker) (40A)
It blocks the power supply at a time of short-circuit due to overload.
- ② MAIN POWER ON/OFF LAMP
With Main Power S/W on, lamp is turned on with pump in motion.
- ③ TEMP CONTROLLER (MODEL: TCS – 500)
- ④ #1 MOTOR R.P.M METER
- ⑤ #1 MOTOR SPEED CONTROL VOLUME
- ⑥ #1 MOTOR S/W (4A)
Motor is usually switched on/off. When pump is overloaded, power is to be cut off from motor to protect pump and motor.
- ⑦ #1 MOTOR ON LAMP
With Pump Motor S/W on, lamp is turned on with pump in motion.
- ⑧ #2 MOTOR R.P.M METER
- ⑨ #2 MOTOR VOLUME
- ⑩ #2 MOTOR S/W (4A)
Motor is usually switched on/off. When pump is overloaded, power is to be cut off from motor to protect pump and motor.
- ⑪ #2 PUMP MOTOR ON LAMP
With Pump Motor S/W on, lamp is turned on with pump in motion.

7-2. Explanation about various electrical parts

◆ TANK HEATER (BS-60)



◆ HEATER standard

- o Rated voltage : 220 [VAC]
- o Caloric value (W) : 1000W x 6
- o Length (L) : 280 [mm]

◆ FILTER BLOCK HEATER (BS-60)



◆ HEATER standard

- o Rated voltage : 220 [VAC]
- o Caloric value (W) : 500 W x 1
- o Length (L) : 100 [mm]

◆ RTD SENSOR

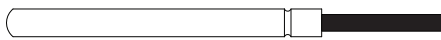

◆ SENSOR standard

- o Type : PT TYPE
- o Length (L) : 30 [mm]

◆ TERMINAL (BS-60)

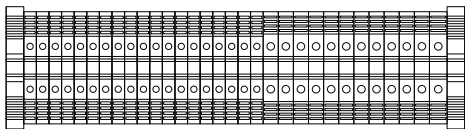

◆ TERMINAL standard

- o MAIN TERMINAL
 - Voltage : 600 [VAC]
 - Current : 35[A]
- o SPARE TERMINAL
 - Voltage : 600 [VAC]
 - Current : 27 [A]

◆ MAIN SWITCH

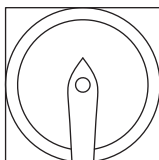

◆ MAIN SWITCH standard

- o Voltage : 220 [VAC]
- o Current : 30 [A]
- o Type : SWITCH

◆ MAIN CIRCUIT BREAKER (BS-60)

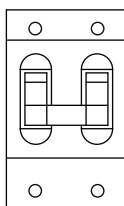

◆ MAIN SWITCH standard

- o Voltage : 220 [VAC]
- o Current : 50 [A]
- o Type : MS TYPE

◆ PUMP SWITCH

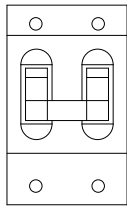

◆ PUMP SWITCH standard

- o Voltage : 220 [VAC]
- o Current : 4 [A]
- o TYPE : MS TYPE

◆ TANK FILTER



◆ FILTER standard

- o 60 MASH

◆ PUMP SWITCH LAMP

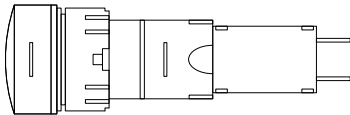

◆ PUMP SWITCH LAMP standard

- o Voltage : 220 [VAC]
- o Color : White

◆ HAT SWITCH

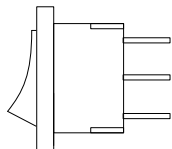

◆ HAT SWITCH standard

- o Voltage : 250 [VAC]
- o Current : 6 [A]

◆ OVERTEMP SWITCH

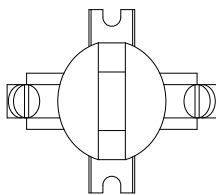

◆ OVERTEMP SWITCH

- o It turns off when overheated in 450 +°F (highest temperature 485°F)
- o With S/W Off, power supply is cut off from TANK HEATER. When safety is ensured with temperature down, S/W is turned on.
- o Used in preventing TANK from being overheated.

◆ RELAY

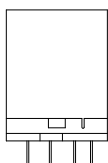

◆ RELAY

- o When OPERATION SIGNAL comes in, it is used as contact point.(Role of starting motor)
- o Voltage : 220 [VAC]

◆ TEFRON WIRE

◆ TEFRON WIRE

- o Teflon wire resistant to high temperature.

◆ S . S . R

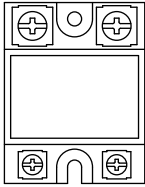

◆ TANK S.S.R SPEC'

- o In Put Voltage : 4 – 32 [VDC]
- o Out Put Voltage : 240 [VAC]
- o Current : 40 [A]

◆ SHUNT TRIP COIL

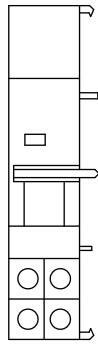

◆ SHUNT TRIP COIL SPEC'

- o Voltage : 100~415 [VAC]

◆ WARM UP SWITCH

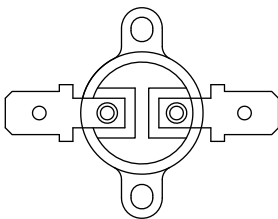

◆ WARM UP SWITCH SPEC'

- o ELECTRICAL RATING : 125[VAC], 15A MAX, RESISTIVE LOAD
250[VAC], 10A MAX, RESISTIVE LOAD
250[VAC], 6(6)A COS 0.6 INDUCTIVE
LOAD 10,000 TIMES
- o OPERATING TEMP RANGE : 0 TO 260°C

7-3. Motor specification and characteristics

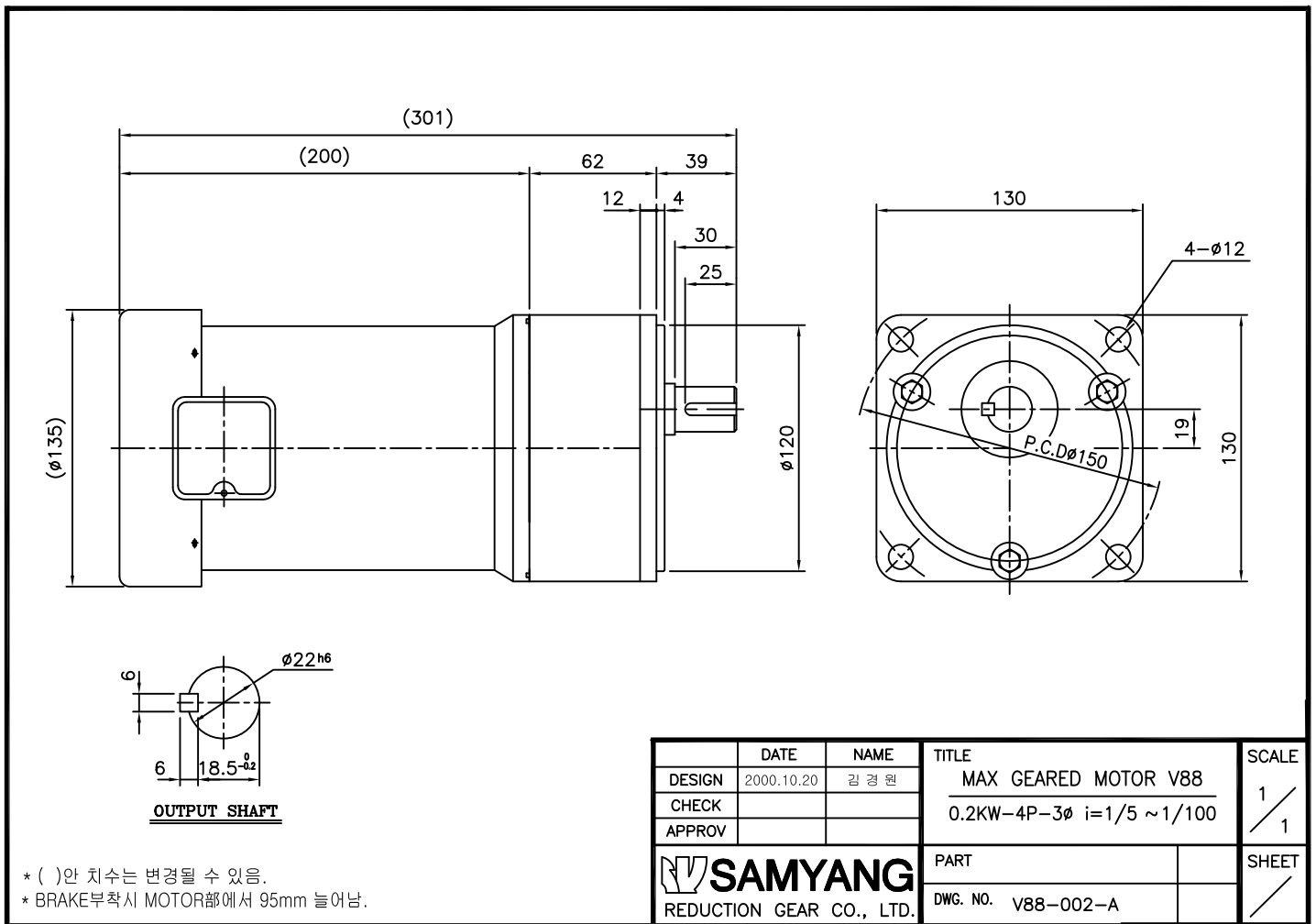

* () 안 치수는 변경될 수 있음.
* BRAKE부착시 MOTOR部에서 95mm 늘어남.

- o single-phase geared motor
- o Rated voltage : 220 VAC
- o Rated current : 1.3[A]
- o Number of revolution : 87 r.p.m
- o Frequency : 50/60 Hz
- o Rated output : 0.2 Kw, 1/4 HP
- o Gear rate : 20 : 1

- ◆ Care to be taken that single-phase geared motor not be overloaded while being used.
- ◆ Motor should not be rotated until temperature for safe operation of the machine is reached.
- ◆ Hot melt should be molten enough to enable motor to rotate.
- ◆ Motor should use rated voltage and rated current.

8. PART LIST

(1) MAIN SWITCH PANEL

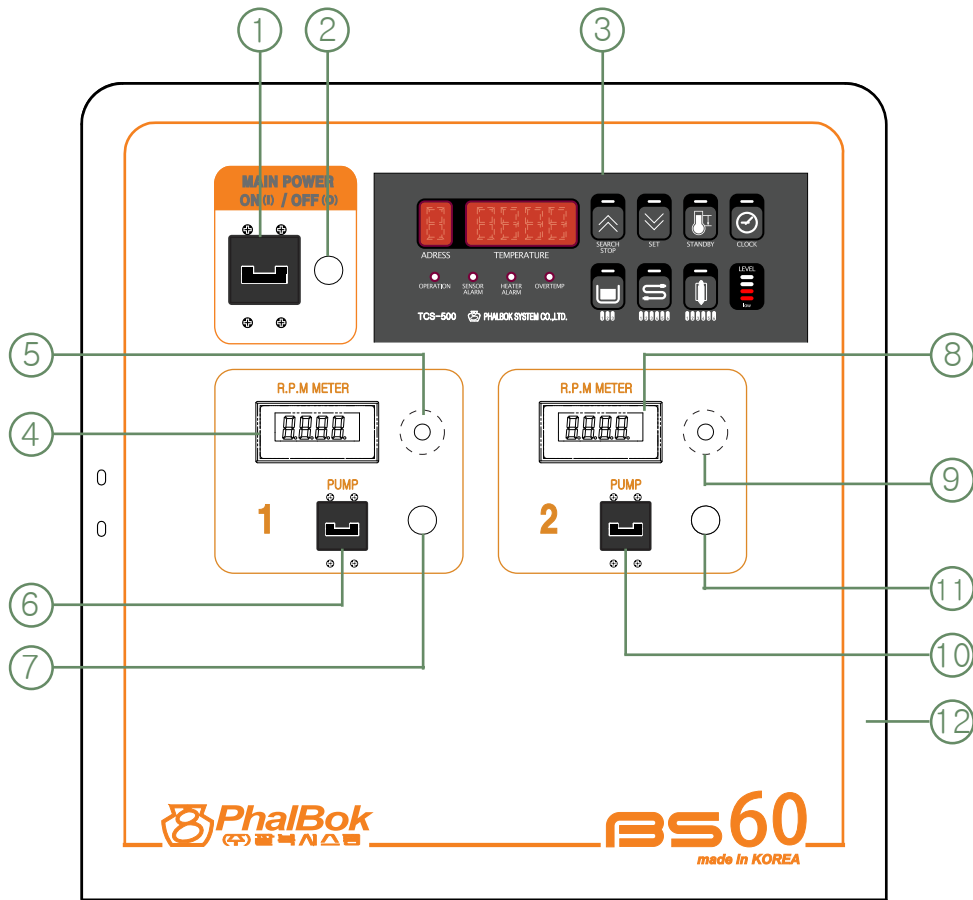

NO.	PART NO.	INDIBATOR
1	911210	MAIN POWER ON/OFF SWITCH(40A)
2	911205	MAIN POWER LAMP
3	TCS-500	TEMP CONTROLLER
4	911212	#1 MOTOR R.P.M METER
5	911213	#1 MOTOR SPEED CONTROL VOLUME
6	911204	#1 PUMP ON/OFF S/W(4A)
7	911205	#1 PUMP ON/OFF S/W LAMP
8	911212	#2 MOTOR R.P.M METER
9	911213	#2 MOTOR SPEED CONTROL VOLUME
10	911204	#2 PUMP ON/OFF S/W(4A)
11	911205	#2 PUMP ON/OFF S/W LAMP
12	913214	FRONT PANEL

(2) FRONT INNER PANEL

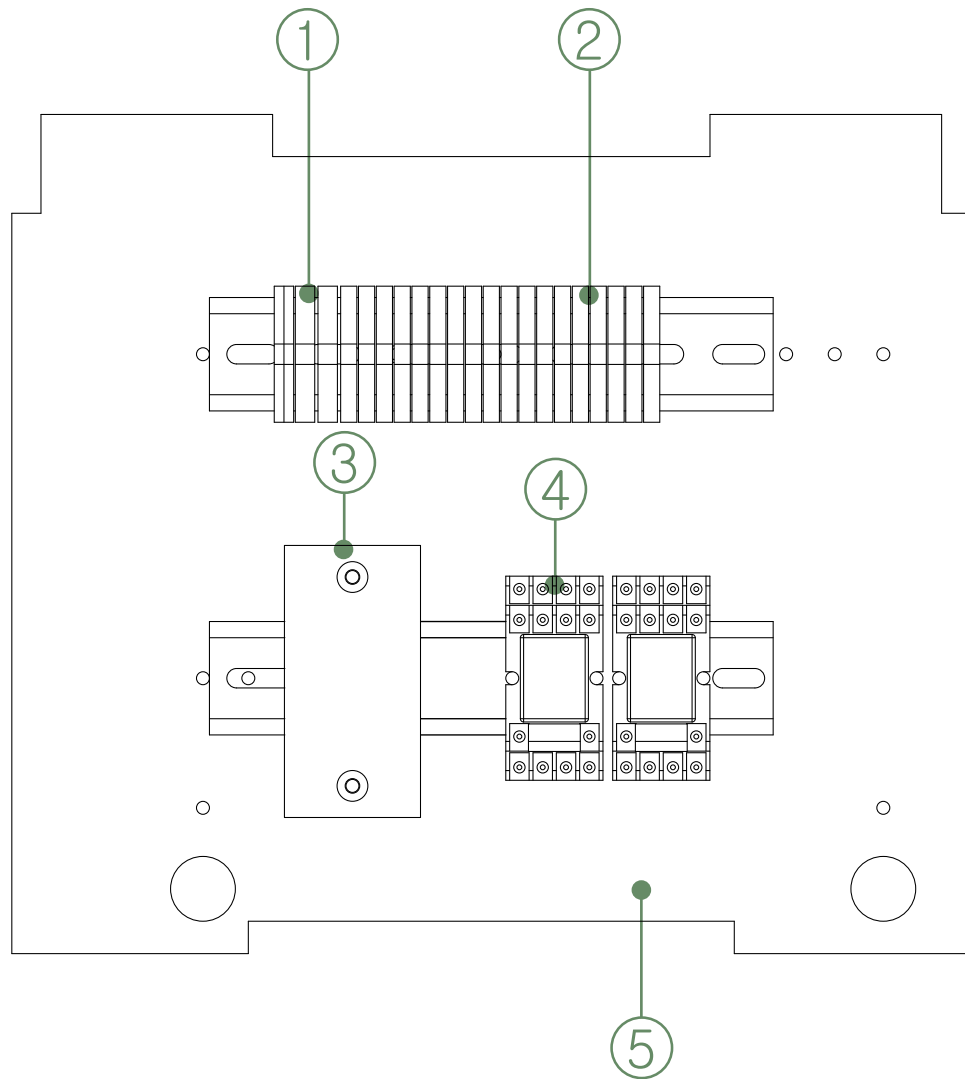

No.	Part No.	INDIBATOR
1	912202	POWER TERMINAL
2	912203	TERMINAL
3	912205	S.S.R
4		RELAY
5	961350	EL WIRE PLATE

(3) Disassembly drawing and explanation for BS-60 TANK

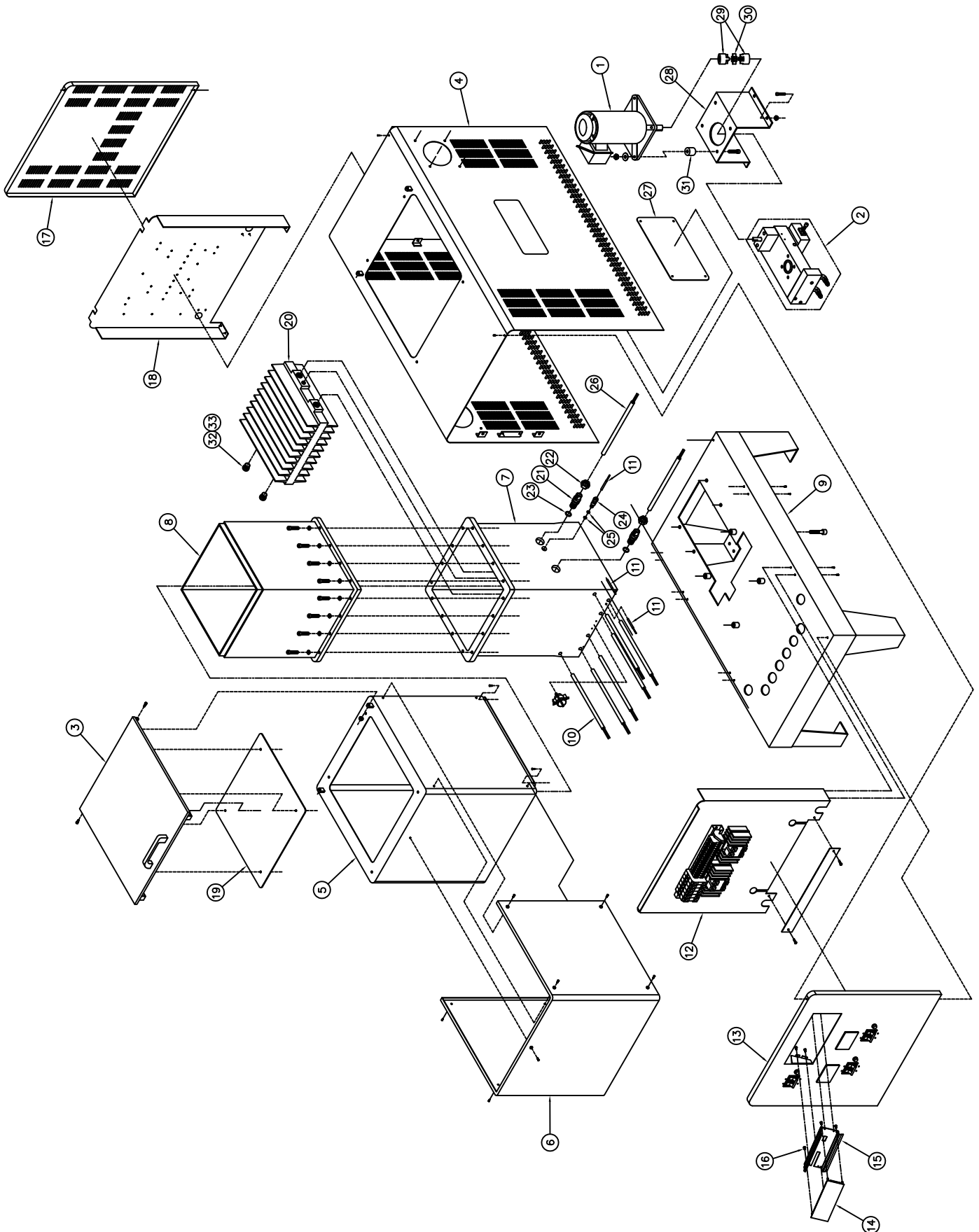

◆ Disassembly drawing and explanation for BS-60 TANK

NO	Q'TY	PART / NO	CONTENT / SPEC'
1	1	913201-1	MOTOR 87 r.p.m
2	1	913502	GEAR PUMP & FILTER BLOCK KIT
3	1	914501	TANK COVER(1)
4	1	914502	TANK OUT COVER (1)
5	1	914603	TANK OUT COVER (2)
6	1	914604	TANK OUT COVER (3)
7	1	913509	HOT MELT TANK (1)
8	1	913521	HOT MELT TANK (2)
9	1	914505	HOT MELT TANK BOTTOM PANNEL
10	6	910403	HEATER 220V x 1000W
11	2	910405	SENSOR PT 100Ω
12	1	914506	FRONT INNER PANEL
13	1	914507	TANK FRONT PANEL
14	1	961102	TEMP CONTROLLER(TCS-500)
15	1	961103	TEMP' CON BRACKET
16	4	41C04010	BOLT (M4 x 10L)
17	1	914508	TANK BACK PANEL
18	1	914509	BACK INNER PANEL
19	1	914510	TANK COVER(2)
20	1	913522	MIDDLE GRID
21	2	914511	MIDDLE GRID HEATER FIX BOLT
22	2	914512	NUT
23	1	511020	O-RING (P-20)
24	1	914513	MODDLE DRID SENSOR FIX BOLT
25	2	512013	O-RING (AN-013)
26	2	232218	HEATER 220V x 1000W

◆ Disassembly drawing and explanation for BS-60 TANK

NO	Q'TY	PART / NO	CONTENT / SPEC'
27	1	914514	MIDDLE GRID SIDE COVER
28	1	913516	MOTOR FIX BRACKET
29	1	913202	COUPLING
30	1	913202-1	SPIDER
31	4	913505	MOTOR FIX SLEEVE
32	2	46F-G	BLANK (PF 3/8")
33	2	511014	O-RING (P-14)

(4) Disassembly drawing and explanation for PUMP BLOCK

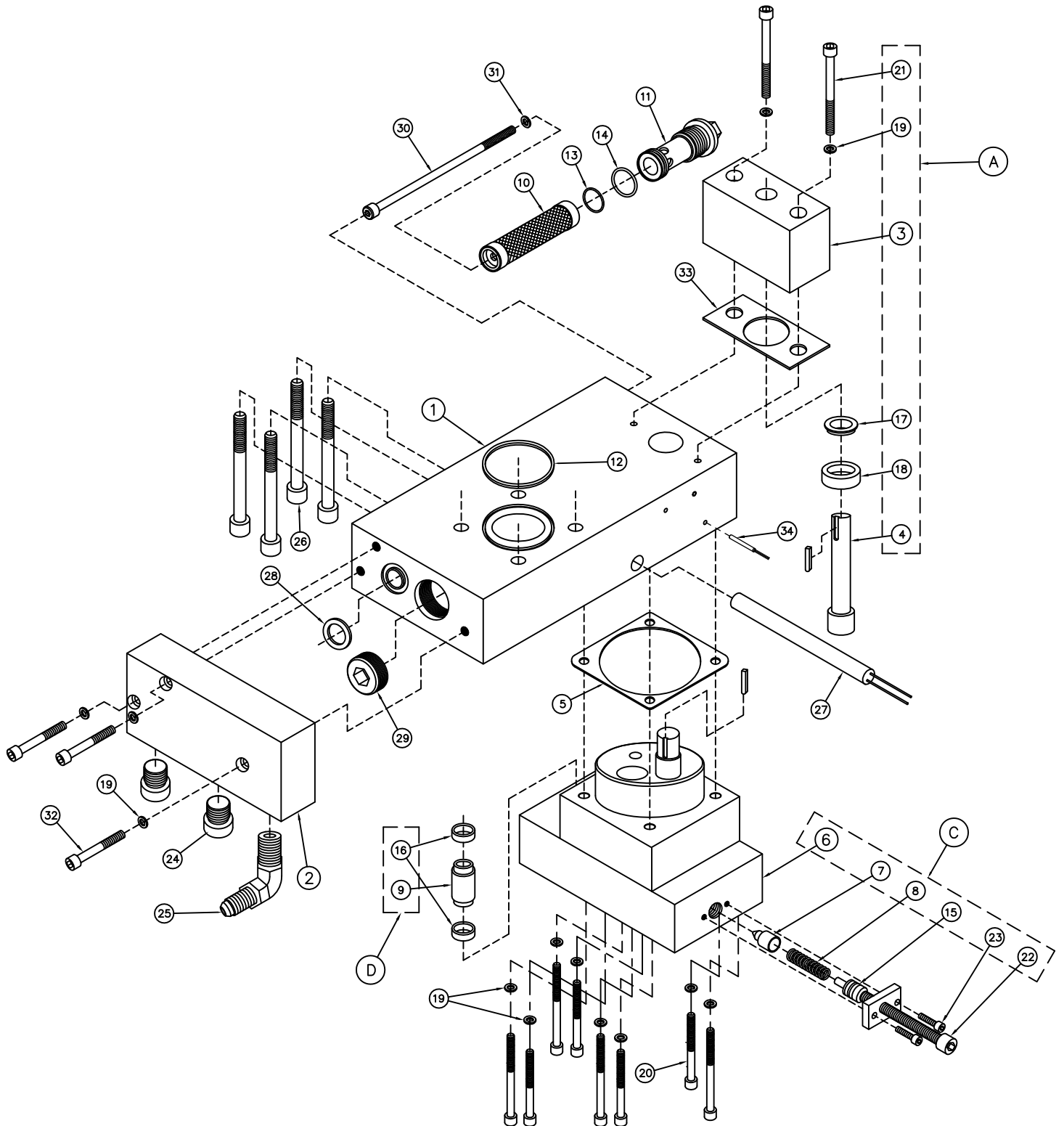

◆ Disassembly drawing and explanation for GP-2 PUMP

NO	Q'TY	PART / NO	CIBTEBT / SPEC'
1	1	914401	FILTER BLOCK
2	1	914402	HOSE BRANCH BLOCK
3	1	914403	DRIVE SHAFT BLOCK
4	1	914404	DRIVE SHAFT
5	1	914301	INSULATION SEAT GASKET
6	1	914304-1 914304-2	GEAR PUMP GP2-20L GEAR PUMP GP2-30L
7	1	914306	MELT CONTROLLING ELEMENT
8	1	914305	SPRING
9	1	914405	F.C.V & FILTER BLOCK CONNECTOR
10	1	961137	FILTER
11	1	412210	FILTER FIXTION BOLT
12	1	52014	TEFLON - RING (OD:52 , ID:46)
13	1	512019	O-RING (AN-19)
14	1	514022	O-RING (G-22)
15	2	512012	O-RING (AN-012)
16	2	52016	TEFLON - RING (OD: 17.7 , ID:14.6)
17	1	51020	SHAFT SEAL
18	1	52020	SHAFT RING
19	13	41L06	M6 SPRING WASHER
20	8	41A06060	WRENCH BOLT (M6 x 60L)
21	5	41A06045	WRENCH BOLT (M6 x 45L)
22	1	412109	F.C.V BOLT
23	2	41A05015	WRENCH BOLT (M5 x 15L)
24	2	46F-E	BLANK (PF 1/4")

◆ Disassembly drawing and explanation for GP-2 PUMP

NO	Q'TY	PART / NO	CONTENT / SPEC'
25	1	914406	HOSE NIPPLE 90° (UNF 9/16"-18)
26	4	41A10065	WRENCH BOLT (M10 x 65L)
27	1	232206	HEATER 220V x 500W
28	1	914408	TEFLON-RING (OD:21 ID:14.6)
29	1	45G-M	BOLT (PT 3/4")
30	1	41A04100	WRENCH BOLT (M4 x 100L)
31	1	41L04	M4 SPRING WASHER
32	3	41A06040	WRENCH BOLT (M6 x 40L)
33	1	914409	DRIVE SHAFT BLOCK GASKET
A	1	914400-1	DRIVE SHAFT KIT
B	1	914400-2	FILTER KIT
C	1	914400-3	F.C.V BOLT SET
D	1	914400-4	F.C.V & FILTER BLOCK CONNECT SET
34	1	910405	SENSOR PT 100Ω

9. How to clean Melt unit

- ① After tank is heated at temperature available for use, HOT MELT should be completely removed from the tank by pumping and then, foreign and carbonized matters should be removed in the bottom, melt grid and wall.
2. Care should be taken that carbonized HOT MELT is carefully removed so that TEFLON COATING in the tank wall is not damaged.
- ③ Get carbonized matters thus removed out of the tank and put in solid paraffin. Have it molten, then circulate in the tank through hose and discharged out of the tank.
- ④ Separate filter from FILTER BLOCK for cleaning.
- ⑤ Assemble back FILTER and put HOT MELT in the tank. Have it molten and discharged out of the TANK. (If HOT MELT and paraffin are mixed, adhesiveness deteriorates.)

10. Finding problem and solution when using HOT MELT APPLICATOR

- ① No power in Tank.
 - o Check if main power is normally supplied to terminal L1,L2 in the tank.
 - o Check if MAIN SWITCH is in working condition.
- ② Despite normal power supply to the TANK, TEMP CONTROLLER does not work.
 - o Check if input FUSE(250V,5A) in TEMP CONTROLLER is in working condition.
- ③ When tank is not heated.
 - o Check if it is in rated voltage.
 - o Check Temperature CONTROLLER.
 - o Check S.S.R contact point inside the tank.
 - o Check if TANK HEATER is disconnected.
- ④ When it is not heated with OVER TEMP LAMP lit.
 - o Check if contact point in OVER TEMP SWITCH is in working condition.
- ⑤ When OVER TEMP LAMP is over-heated while working.
 - o Check TEMP CONTROLLER.
 - o Check S.S.R contact point in TANK HEATER.
- ⑥ When motor does not work in normal temperature.
 - o Check if contact point in TANK OPERATION relay is attached.
- ⑦ When pump does not work while MOTOR works normally.
 - o Check if MOTOR COUPLING is broken.
 - o Check if GEAR PUMP is broken.
- ⑧ When HOT MELT leaks from TANK and FILTER BLOCK.
 - o Check if BOLT is locked.
 - o Check if O-RING in Gear Pump is broken.
- ⑨ When Motor comes to a stop or is loaded during normal rotation.
 - o Check if temperature inside the TANK is normal.
 - o Check if F.C.V pressure is adjusted too high
 - o Check if there are too much carbonized matters in TANK FILTER.
It may cause load, leading to halt,
- ⑩ When Motor is too noisy.
 - o It may be caused by excessive overloaded MOTOR.
 - o Being merely a noise coming from GEAR BOX in MOTOR, it does not affect function.
 - o Check if there are enough amount of grease in the GEAR BOX.

11. Finding problem and solution when using HOT MELT

Situation	Cause	Solution
1. Injection	<ol style="list-style-type: none"> Melting temperature is too low. Viscosity of HOT MELT is too high. Ambient temperature is too low. Adherend and nozzle are too far away. Error in nozzle selection. Pumping pressure is too low. 	<ol style="list-style-type: none"> Raise melting temperature. Use HOT MELT of low viscosity. Raise ambient temperature for use. Keep them closer to each other. Use of an appropriate nozzle. Raise Pumping pressure.
2. Loosen	<ol style="list-style-type: none"> Nozzle tip is crushed. Valve sheet in gun is broken. 	<ol style="list-style-type: none"> Cleaning or replacement of nozzle. Replace valve sheet .
3. Splash & Gas Discharge	<ol style="list-style-type: none"> Pumping pressure is too high. Air mixed with adhesive. Temperature is too high. Air pin valve sheet is broken. 	<ol style="list-style-type: none"> Lower pumping pressure. Change adhesive. Lower operating temperature. Replacement of air pin valve
4. Splashing all around	<ol style="list-style-type: none"> Discharging pressure is too high. Viscosity of HOT MELT is too low. 	<ol style="list-style-type: none"> Lower discharge pressure. Replacement by HOT MELT of high viscosity.
5. HOT MELT Carbonization and gelation	<ol style="list-style-type: none"> Melting temperature of HOT MELT too high Defect in thermal management tool Poor heating stability of HOT MELT 	<ol style="list-style-type: none"> Lower temperature. Adjustment and replacement of heating controller Replacement of HOT MELT
6. HOT MELT Bad percolation	<ol style="list-style-type: none"> Operating temperature of HOT MELT is too high. Coating amount too little. IMPROPER MELT CHOOSE. OPEN TIME OF ADHESIVE TOO SHORT. 	<ol style="list-style-type: none"> Lower temperature. Raise pumping pressure a little. Increase coating amount by nozzle of larger diameter. Replace with proper HOT MELT. Set OPEN TIME. Replace by HOT MELT with long OPEN TIME. Increase coating amount. Raise adherend temperature. Raise operating temperature.
7. Falls after compression	<ol style="list-style-type: none"> compression is not enough. SET TIME of HOT MELT not proper. 	<ol style="list-style-type: none"> compression process. Adjust set time. Lower operating temperature a little.
8. Open time too long	<ol style="list-style-type: none"> Coating amount too little. Operating temperature a little is too low. Ambient temperature and adherend temperature are too low. Adherend and nozzle are too far away. 	<ol style="list-style-type: none"> Increase discharge amount. (pumping pressure ↑ , nozzle diameter ↑) Raise operating temperature. Raise ambient temperature. Pre-heat adherend Reposition nozzle closer to substrate.